

V-BLOCK SETS



6896-10

6896-11

- Hold cylindrical workpieces for inspection and machining
- Two V-blocks per set
- Made of alloy steel
- Hardened to HRC60±2
- V groove on the top for large shafts
- V groove on the bottom for small shafts (except 6896-10)

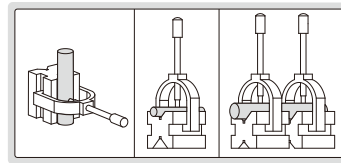

Code	Size (LxWxH)	Range of shafts (Ød)	Parallelism of both V grooves to top and bottom sides	Squareness of both V grooves to front and back sides	Height difference of a matched pair
6896-10	25x20x20mm	3-20mm	3µm	3µm	3µm
6896-11	50x40x40mm	5-30mm	5µm	5µm	5µm
6896-12	80x63x63mm	7-63mm	5µm	5µm	5µm
6896-13	100x80x80mm	7-80mm	5µm	5µm	5µm
6896-14	70x140x140mm	9-140mm	5µm	5µm	5µm

12

SIDE LIE-DOWN USE IS POSSIBLE

V-BLOCK SETS

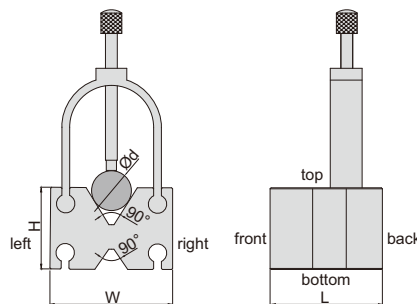
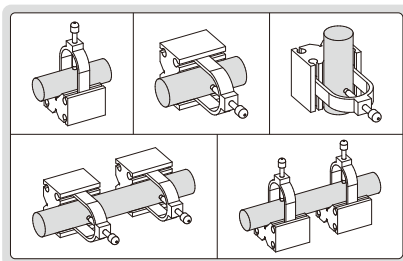

6803-1

- Hold cylindrical workpieces for inspection and machining
- Two V-blocks per set
- Made of alloy steel
- Hardened to HRC60±2
- V groove on the top for large shafts
- V groove on the bottom for small shafts

Code	Size (LxWxH)	Range of shafts (Ød)	Parallelism of both V grooves to top, bottom, left, right sides	Squareness of both V grooves to front and back sides	Height difference of a matched pair
6803-1	55x60x40mm	4-35mm	5µm	5µm	5µm
6803-2	65x70x45mm	4-47mm	5µm	5µm	5µm

V-BLOCK SET

SIDE LIE-DOWN USE IS POSSIBLE

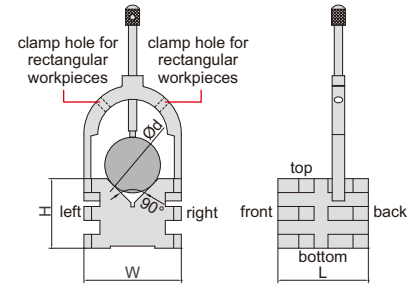
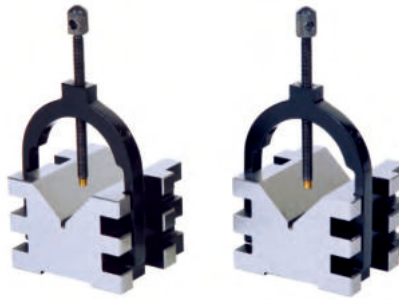
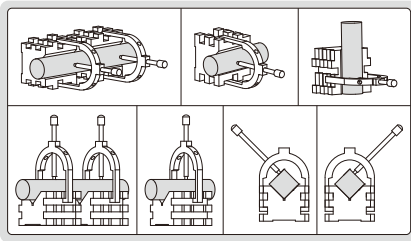

- Hold cylindrical or rectangular workpieces for inspection and machining
- Two V-blocks per set
- Made of alloy steel
- Hardened to HRC60±2
- Applicable for cylinder with diameter (Ød): 5-50mm
- Applicable for rectangular workpieces with thickness: ≤35mm

6802-1

Code	Size (LxWxH)	Parallelism of V groove to top, bottom, left, right sides	Squareness of V groove to front and back sides	Height difference of a matched pair
6802-1	65x70x50mm	5µm	5µm	5µm

V-BLOCK

12

the adjustable screw can support the block and prevent tilting



side groove is for shouldered studs and pins



6804-M2

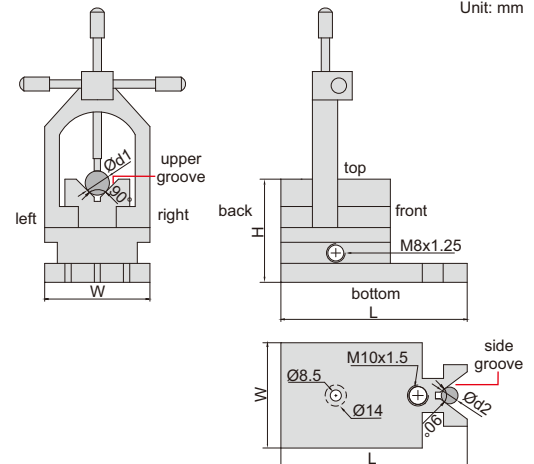

Unit: mm

- Hold cylindrical workpieces for inspection and machining
- Made of alloy steel
- Hardened to HRC60±2

Code	Size (LxWxH)	Range of shafts (Ød1 and Ød2)	Parallelism of upper groove to bottom, left and right sides	Squareness of upper groove to back side	Parallelism of side groove to back side
6804-M2	90x48x48mm	5-33mm	5µm	5µm	5µm

V-BLOCK SETS

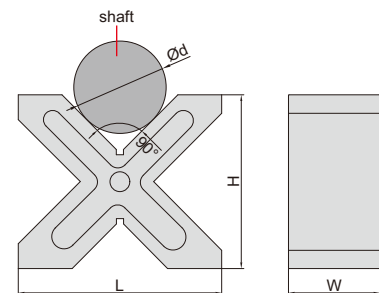
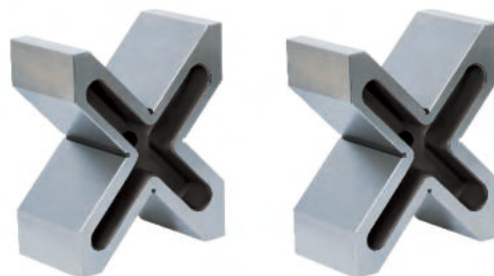
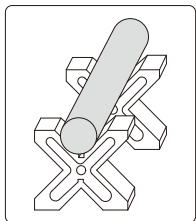

- For positioning cylindrical workpieces
- Two V-blocks per set
- Each V-block has four 90° V-grooves
- Hardness HB170-240

6805-2

Code	Size (LxHxW)	Range of shafts (Ød)	Parallelism of four V grooves to all sides	Height difference of a matched pair
6805-1	150x130x75mm	8-120mm	15µm	20µm
6805-2	200x170x90mm	12-180mm	15µm	20µm

V-BLOCK SETS

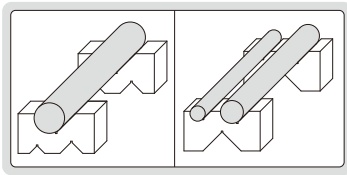

6887-3

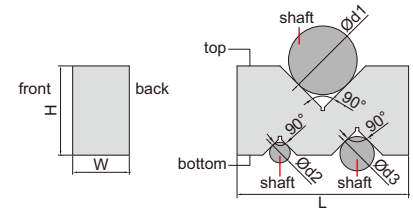

- Two V-blocks per set
- Made of hardened tool steel

Code	Size (LxWxH)	Range of shafts (Ød1)	Range of shafts (Ød2)	Range of shafts (Ød3)
6887-1	50x19x24mm	3-32mm	3-16mm	3-22mm
6887-2	75x24x35mm	3-50mm	3-20mm	3-32mm
6887-3	100x33x52mm	3-68mm	3-26mm	3-40mm
6887-4	125x44x69mm	3-87mm	3-34mm	3-50mm

Code	Parallelism of three V grooves to top and bottom sides	Height difference of a matched pair
6887-1	5µm	5µm
6887-2	5µm	5µm
6887-3	5µm	5µm
6887-4	5µm	5µm

ROLLER BEARING V-BLOCK SETS

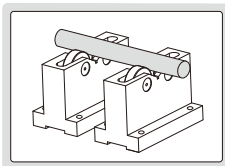

6888-1

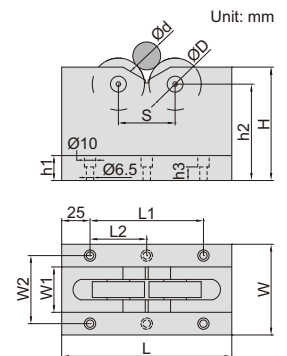

- Runout accuracy: 5µm
- Parallelism of bearings to bottom: 12µm
- Two V-blocks per set
- Workpieces don't get damaged due to bearings
- Suitable for heavy workpieces

Code	Size (LxWxH)	Code of bearings	Diameter of bearings (ØD)	Range of shafts (Ød)	Load capacity
6888-1	150x60x100mm	16004 ZZ	42mm	25-70mm	500kg
6888-2	150x80x100mm	6303 ZZ	47mm	5-55mm	1000kg
6888-3	230x100x150mm	6306 ZZ	72mm	70-200mm	1000kg

Code	W1	W2	h1	h2	h3	L1	L2	S
6888-1	22	44	20	85	12	100	-	60
6888-2	40	60	22	85	12	100	-	50
6888-3	60	80	30	124	20	180	90	120

GRANITE V-BLOCK SETS

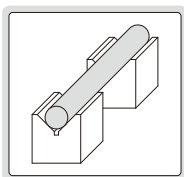

6897-1

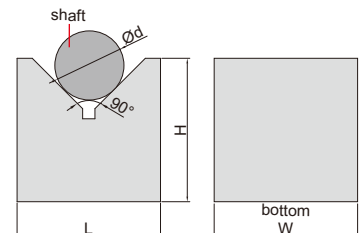

- Two V-blocks per set

Code	Size (LxWxH)	Range of shafts (Ød)	Parallelism of V groove to bottom	Height difference of a matchet pair
6897-1	70x50x70mm	6-75mm	4µm	5µm
6897-2	100x50x70mm	6-99mm	4µm	5µm

MAGNETIC V-BLOCKS (ADVANCED TYPE)

HARDENED SURFACES

HIGH PRECISION

STRONG MAGNETIC FORCE

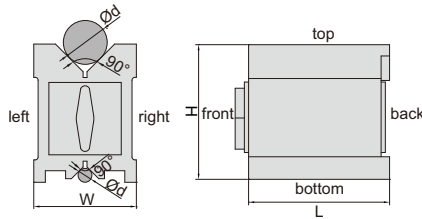

6889-11

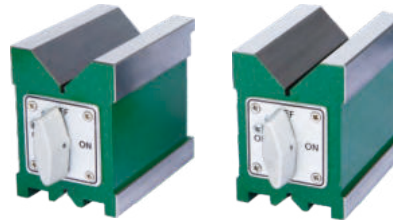

6889-1

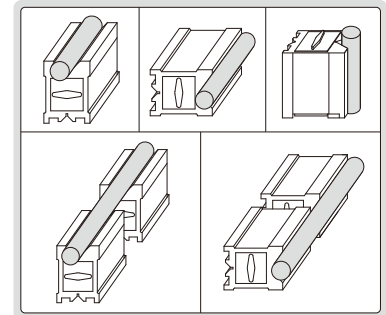

- Hardened, high accuracy, strong magnetic force, for grinding, light milling, drilling and inspection of round and square workpieces
- All working surfaces are hardened to HRC60±2
- Magnetic force on top, bottom and two V grooves
- V groove on the top for large shafts
- V groove on the bottom for small shafts
- Suitable for cast iron surface plates and granite surface plates

Individual

Code	Size (LxWxH)	Range of shafts (Ød)	Magnetic force	Parallelism of V grooves to top, bottom, left, right sides	Squareness of V grooves to back side
6889-11	75x56x75mm	5-40mm	85kgf	5µm	5µm
6889-22	100x70x95mm	5-65mm	150kgf	5µm	5µm
6889-33	150x75x100mm	5-70mm	190kgf	6µm	6µm
6889-55	160x125x130mm	5-140mm	220kgf	12µm	12µm
6889-44	200x125x150mm	10-140mm	400kgf	12µm	12µm

Matched pair

Code	Size (LxWxH)	Range of shafts (Ød)	Magnetic force	Parallelism of V grooves to top, bottom, left, right sides	Squareness of V grooves to back side	Height difference of a matched pair
6889-1	75x56x75mm	5-40mm	85kgf	5µm	5µm	5µm
6889-2	100x70x95mm	5-65mm	150kgf	5µm	5µm	5µm
6889-3	150x75x100mm	5-70mm	190kgf	6µm	6µm	6µm
6889-5	160x125x130mm	5-140mm	220kgf	12µm	12µm	12µm
6889-4	200x125x150mm	10-140mm	400kgf	12µm	12µm	12µm

MAGNETIC V-BLOCK (ECONOMIC TYPE)

ATTENTION: NOT SUITABLE FOR STEEL OR IRON SURFACES, OTHERWISE THE MAGNETIC FORCE WILL BE REDUCED

ATTENTION: NOT HARDENED

- Hold cylindrical workpieces for inspection and machining
- Supplied in single piece
- Not hardened
- Not suitable for steel or iron surfaces, otherwise the magnetic force will be reduced

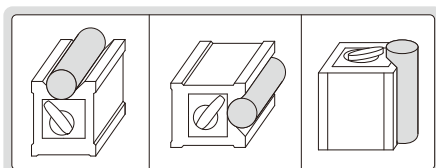

6890-702

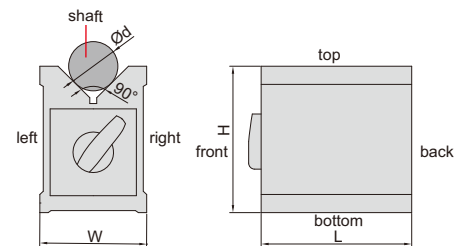

Code	Size (LxWxH)	Range of shafts (Ød)	Magnetic force	Parallelism of V groove to top, bottom, left and right sides	Squareness of V groove to back side
6890-702	70x60x73mm	6-44mm	56kgf	10µm	10µm

ATTENTION: NOT SUITABLE FOR STEEL OR IRON SURFACES, OTHERWISE THE MAGNETIC FORCE WILL BE REDUCED

ATTENTION: NOT HARDENED

MAGNETIC V-BLOCKS (ECONOMIC TYPE)

- Hold cylindrical workpieces for inspection and machining
- Supplied in single piece
- Not hardened
- V groove on the top for large shafts
- V groove on the bottom for small shafts
- Not suitable for steel or iron surfaces, otherwise the magnetic force will be reduced

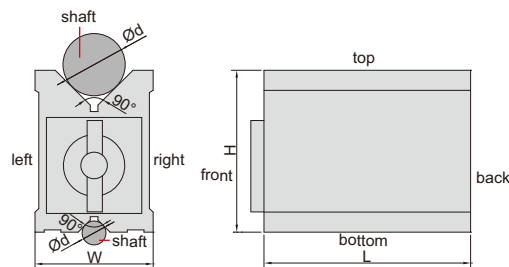
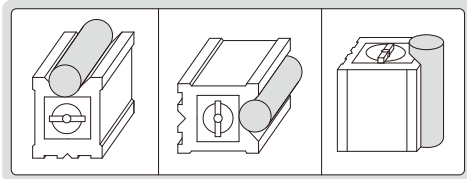

6801-1201

Code	Size (LxWxH)	Range of shafts ($\varnothing d$)	Magnetic force	Parallelism of V grooves to top, bottom, left, right side	Squareness of V grooves to back side
6801-1201	80x70x95mm	6-67mm	64kgf	10 μ m	10 μ m
6801-1202	100x70x95mm	6-67mm	80kgf	10 μ m	10 μ m
6801-1203	120x70x95mm	6-67mm	96kgf	10 μ m	10 μ m

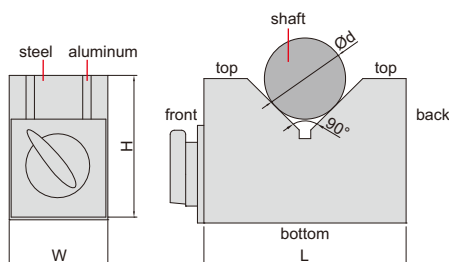

MAGNETIC V-BLOCK SETS

ATTENTION: NOT HARDENED, DO NOT ROTATE WORKPIECES ON V-BLOCKS

ATTENTION: LOW MAGNETIC FORCE

- Hold cylindrical workpieces for inspection, not suitable for machining due to low magnetic force
- Two V-blocks per set
- Hardness HRB70

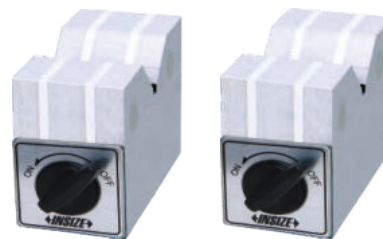

6891-1

Code	Size (LxWxH)	Range of shafts ($\varnothing d$)	Magnetic force	Parallelism of V groove to bottom and back sides	Height difference of a matched pair
6891-1	70x40x50mm	6-46mm	8kgf	10 μ m	10 μ m
6891-3	150x50x100mm	6-125mm	14kgf	10 μ m	10 μ m

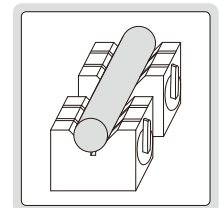

12

ATTENTION: NOT HARDENED, DO NOT ROTATE WORKPIECES ON V-BLOCKS

MAGNETIC SQUARE WITH V GROOVE

- Hold flat and cylindrical workpieces for inspection and machining
- Magnetic force on top, left, right and V grooves
- Parallelism and squareness of top, bottom, left, right and back: 20 μ m
- Parallelism and squareness of V grooves to top, bottom, left, right and back: 20 μ m



6539-100

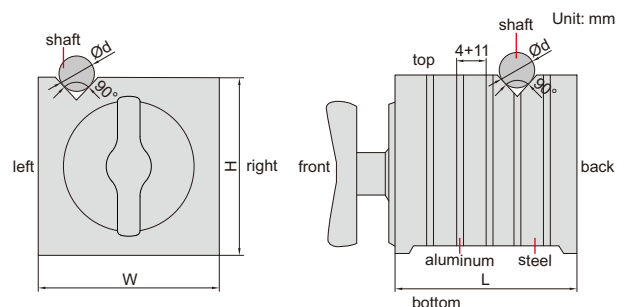

Code	Size (LxWxH)	Magnetic force of V grooves		Magnetic force of top, left and right sides		Range of shafts ($\varnothing d$)
		On granite surface plate	On cast iron plate	On granite surface plate	On cast iron plate	
6539-100	100x100x100mm	30kgf	25kgf	50kgf	30kgf	5-35mm

MAGNETIC INDUCTION V-BLOCK

ATTENTION: NOT HARDENED, DO NOT ROTATE WORKPIECES ON V-BLOCKS

- Hold cylindrical workpieces for inspection and machining
- To be used on magnetic chucks
- Supplied in single piece
- V groove on the top for large shafts
- V groove on the bottom for small shafts
- Hardness HRB70



6892-1

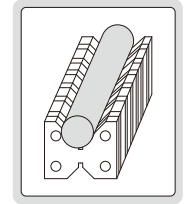
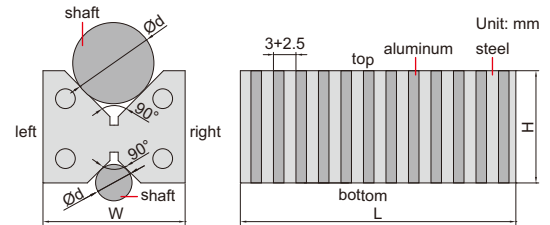

Code	Size (LxWxH)	Range of shafts ($\varnothing d$)	Pole pitch	Parallelism of both V grooves to top and bottom sides
6892-1	110x60x48mm	6-50mm	3+2.5mm	10 μ m

MAGNETIC INDUCTION V-BLOCK SET

ATTENTION: NOT HARDENED, DO NOT ROTATE WORKPIECES ON V-BLOCKS

- Hold cylindrical workpieces for inspection and machining
- To be used on magnetic chucks
- Two V-blocks per set
- V groove on the top for large shafts
- V groove on the bottom for small shafts
- Hardness HRB70
- Copper magnetic strips

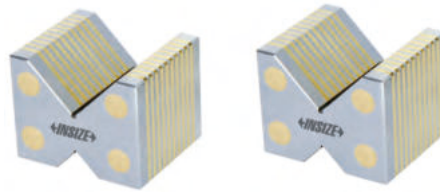

6878-1

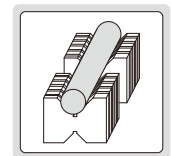
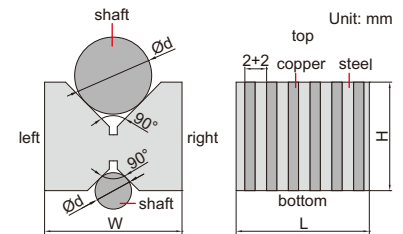

Code	Size (LxWxH)	Range of shafts ($\varnothing d$)	Pole pitch	Parallelism of both V grooves to top and bottom sides	Height difference of a matched pair
6878-1	49x58x46mm	5-56mm	2+2mm	10 μ m	10 μ m

MAGNETIC INDUCTION V-BLOCK SET (ECONOMIC TYPE)

ATTENTION: NOT HARDENED, DO NOT ROTATE WORKPIECES ON V-BLOCKS

- Hold cylindrical workpieces for inspection and machining
- To be used on magnetic chucks
- Two V-blocks per set
- V groove on the top for large shafts
- V groove on the bottom for small shafts
- Hardness HRB70



6899-1

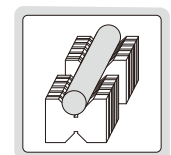
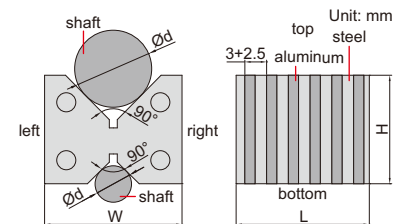

Code	Size (LxWxH)	Range of shafts ($\varnothing d$)	Pole pitch	Parallelism of both V grooves to top and bottom sides	Height difference of a matched pair
6899-1	55x60x48mm	6-50mm	3+2.5mm	10 μ m	10 μ m